

ATTACHMENT I

(Pictures of the EUT and Electrical Schemes)

1 PICTURES

Front view 1 (SOFAR 2700TL-G3, SOFAR 3000TL-G3, SOFAR 3300TL-G3)



Back view 1 (SOFAR 2700TL-G3, SOFAR 3000TL-G3, SOFAR 3300TL-G3)



Front view 2 (SOFAR 1100TL-G3, SOFAR 1600TL-G3, SOFAR 2200TL-G3)



Back view 2 (SOFAR 1100TL-G3, SOFAR 1600TL-G3, SOFAR 2200TL-G3)



IEC 61683: 1999

Side View (SOFAR 2700TL-G3, SOFAR 3000TL-G3, SOFAR 3300TL-G3)

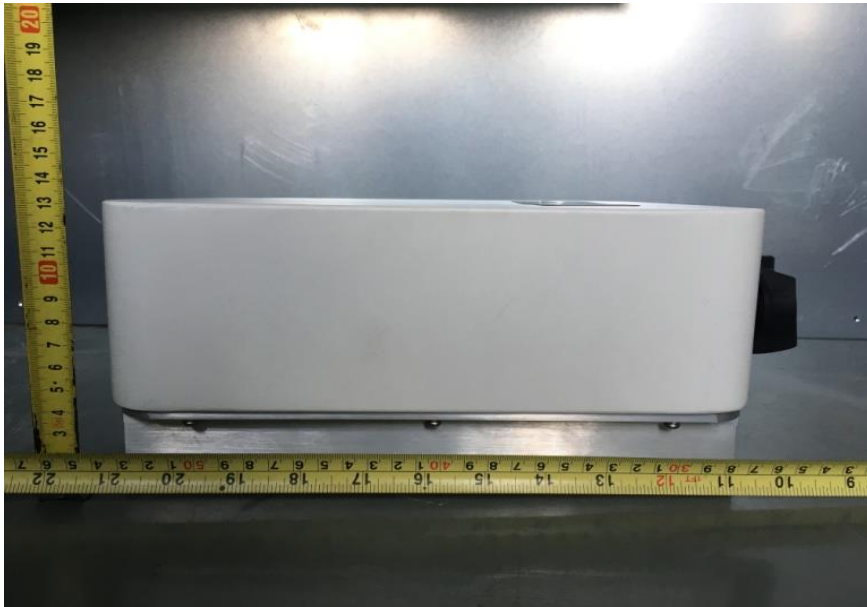

Side View (SOFAR 1100TL-G3, SOFAR 1600TL-G3, SOFAR 2200TL-G3)

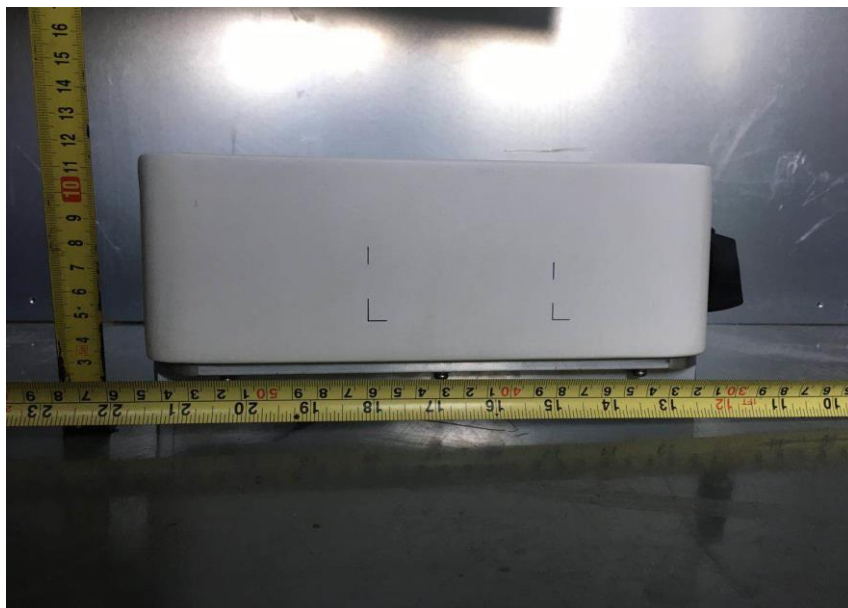

Internal view of enclosure (SOFAR 2700TL-G3, SOFAR 3000TL-G3, SOFAR 3300TL-G3)

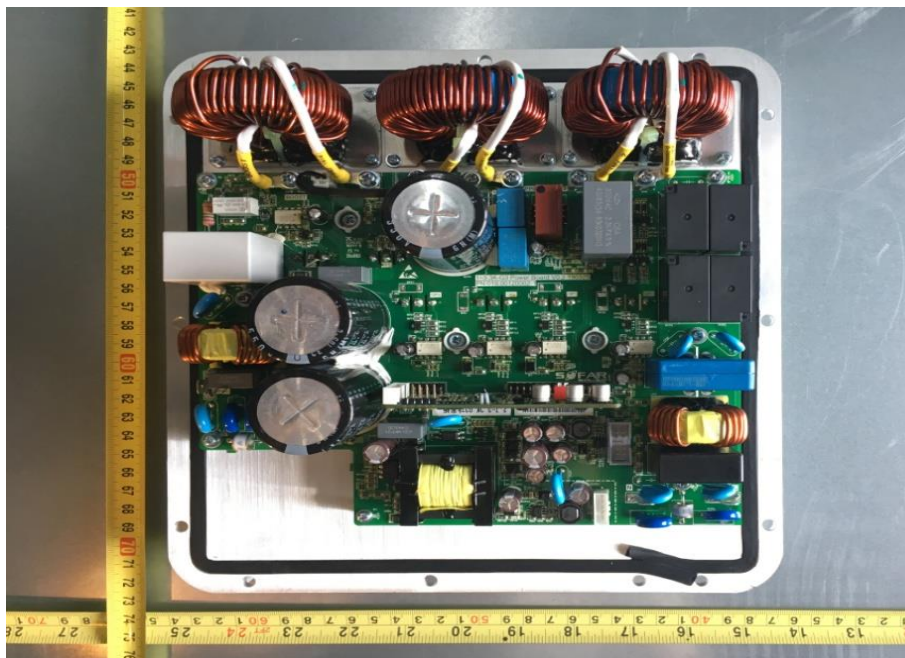

Internal view of enclosure (SOFAR 1100TL-G3, SOFAR 1600TL-G3, SOFAR 2200TL-G3)

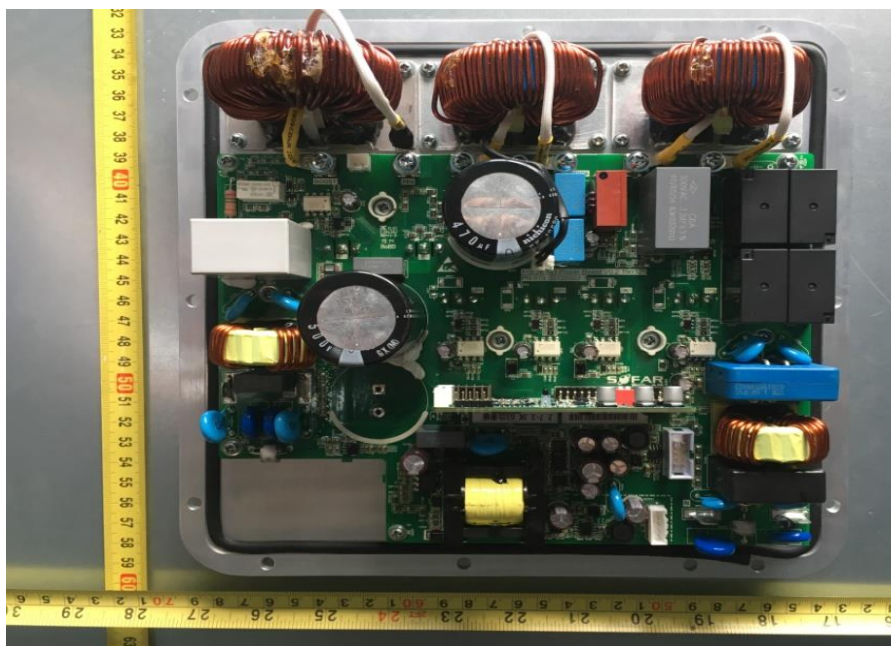

Front side of main board 1 (SOFAR 2700TL-G3, SOFAR 3000TL-G3, SOFAR 3300TL-G3)

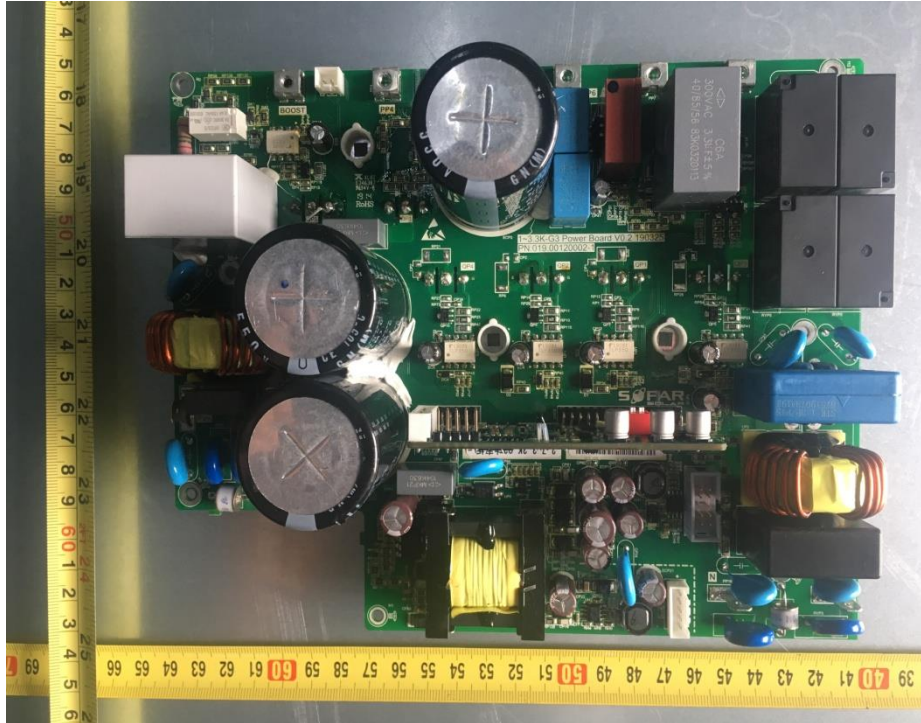

Back side of main board 1 (SOFAR 2700TL-G3, SOFAR 3000TL-G3, SOFAR 3300TL-G3)

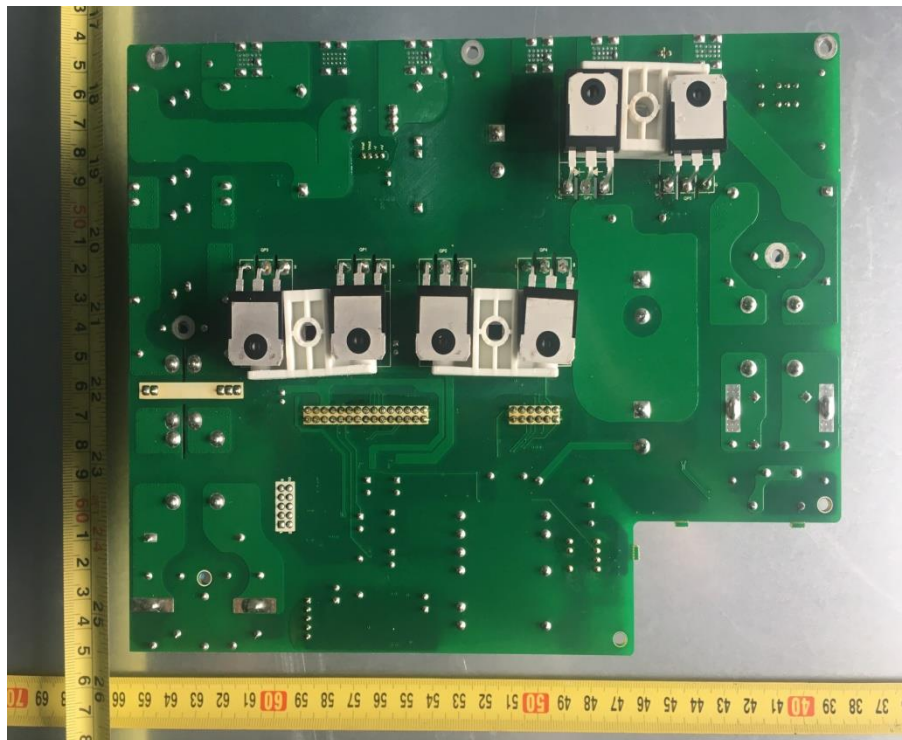

Front side of main board 2 (SOFAR 1100TL-G3, SOFAR 1600TL-G3, SOFAR 2200TL-G3)

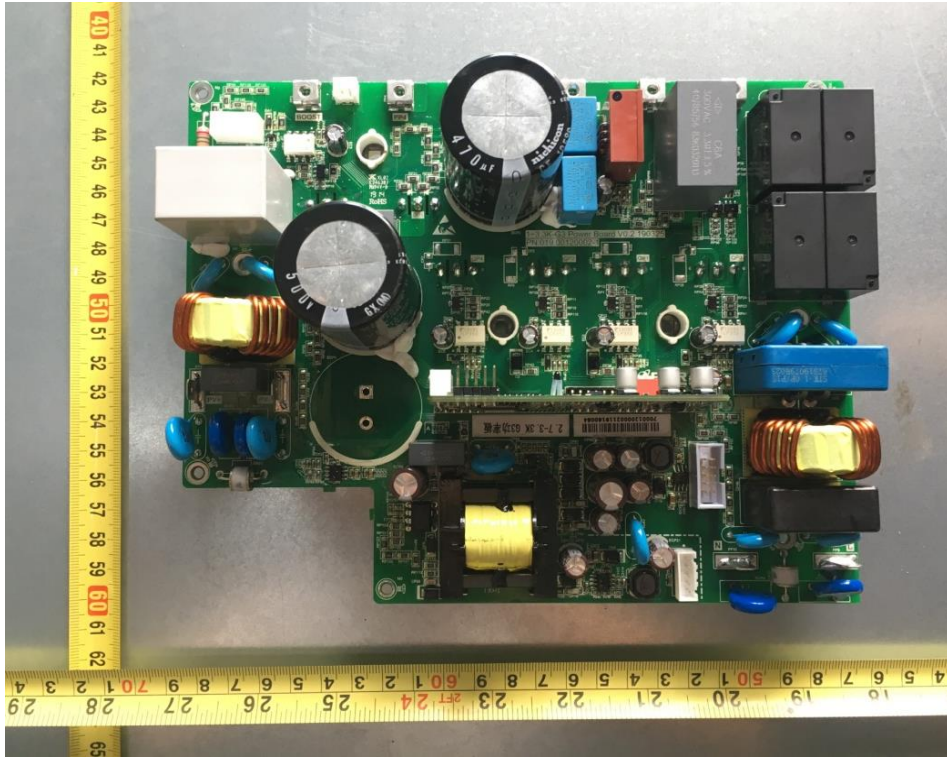

Back side of main board (SOFAR 1100TL-G3, SOFAR 1600TL-G3, SOFAR 2200TL-G3)

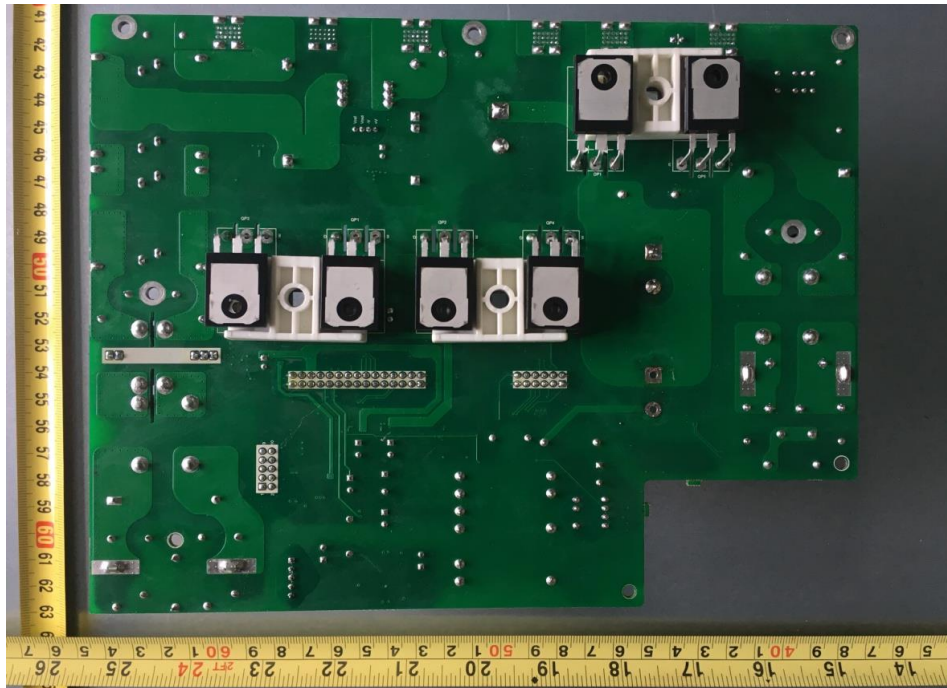

Front side of Control board

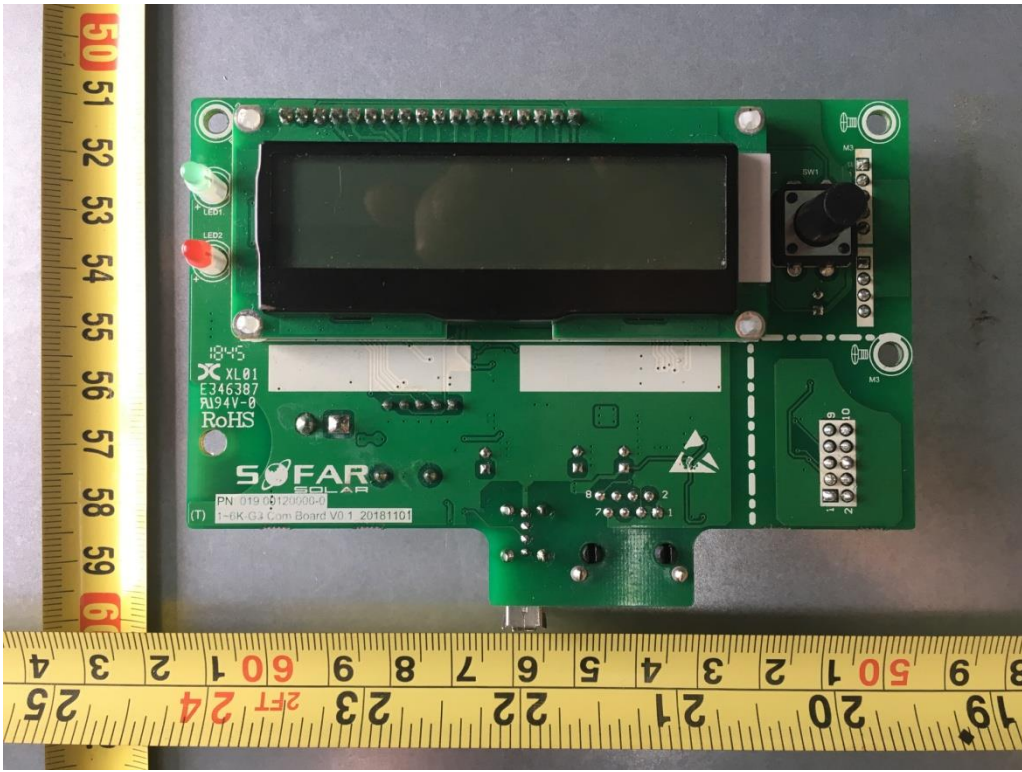

Front side of Control board

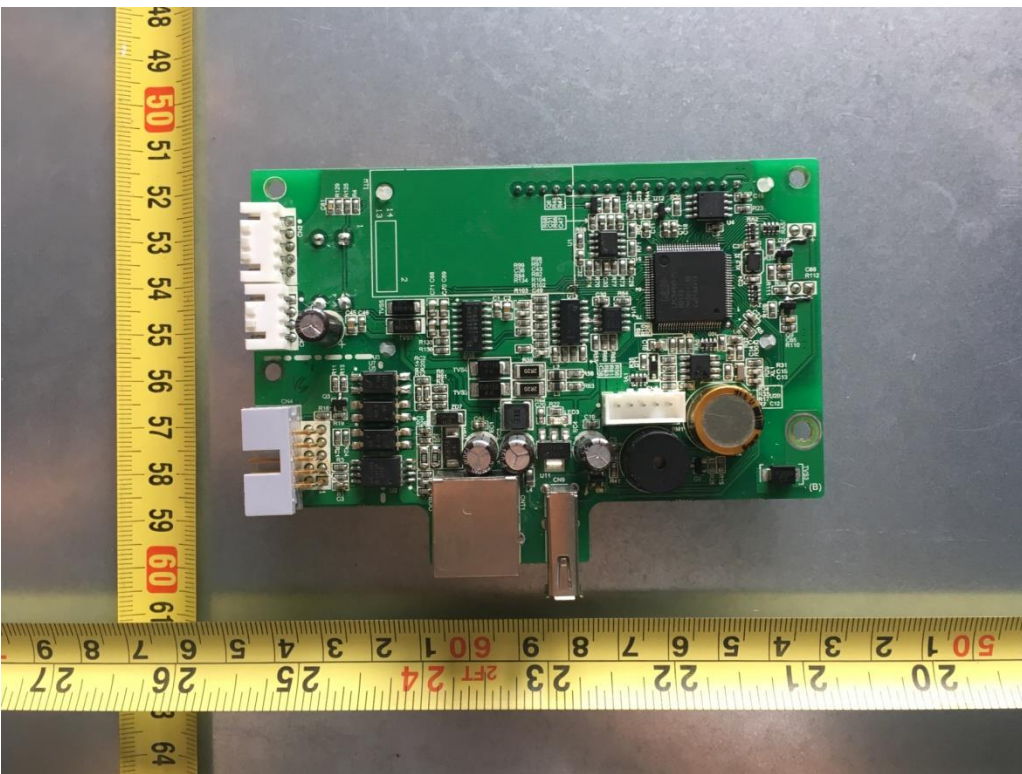

Front view of RS 232 board

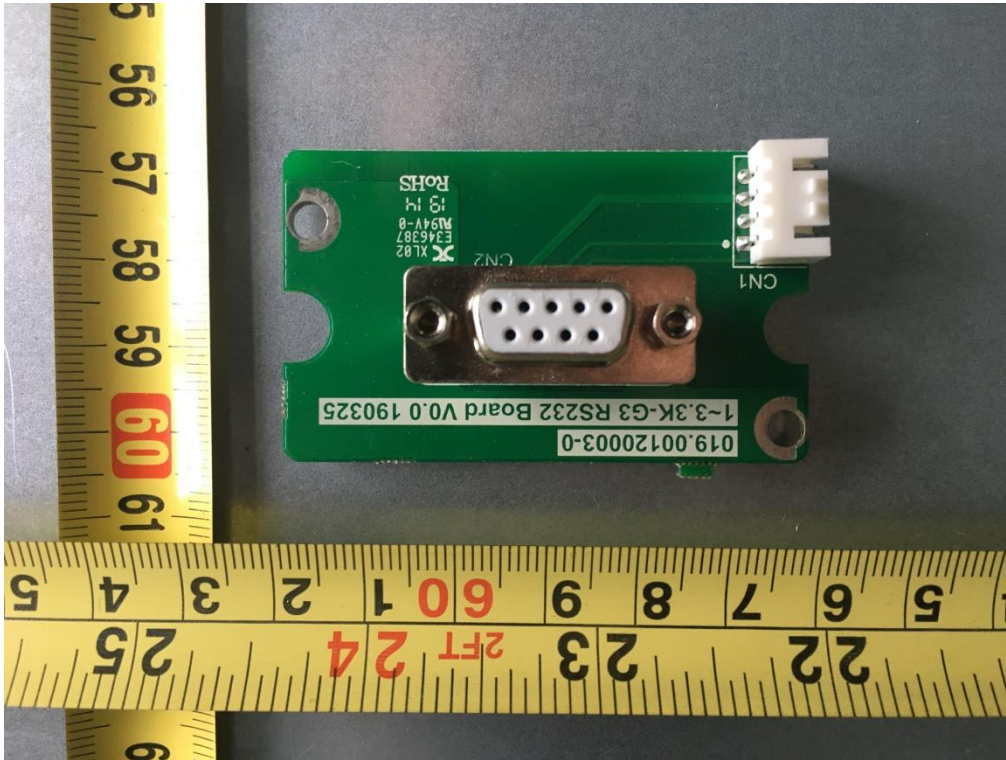

Back view of RS 232 board

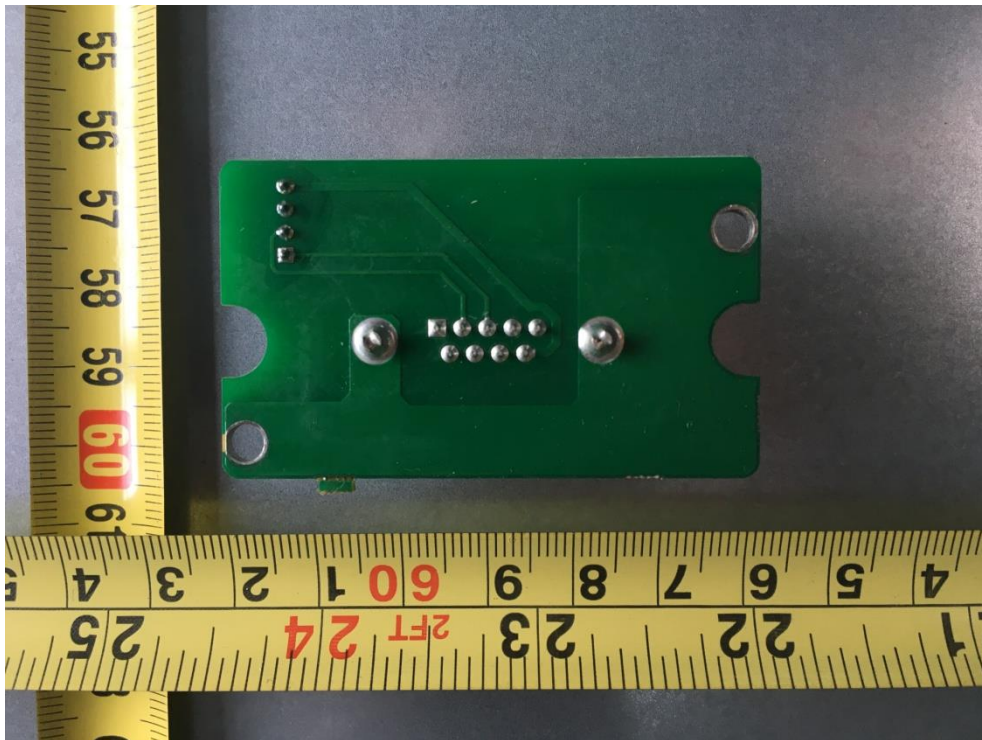

IEC 61683: 1999

DC&AC Terminals



Grounding

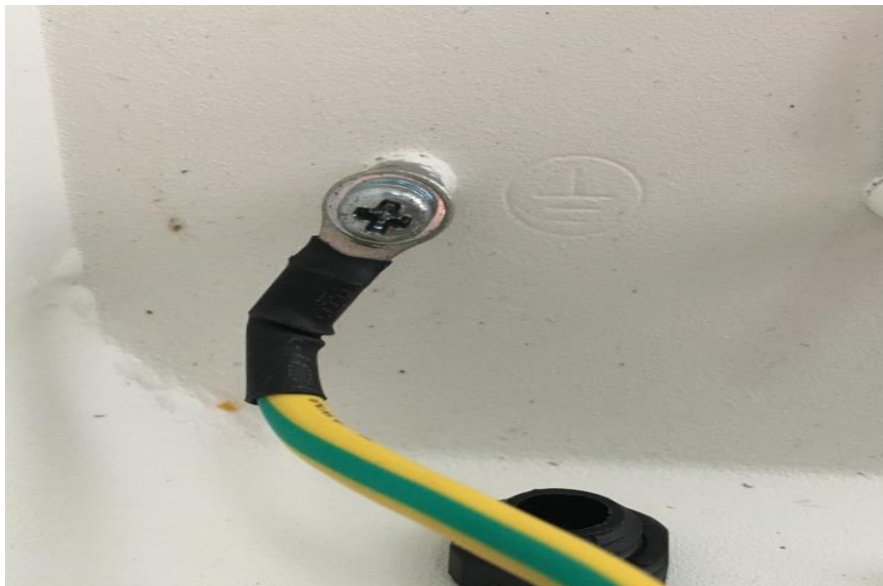

Software Number (SOFAR 2700TL-G3, SOFAR 3300TL-G3)



Software Number (SOFAR 1100TL-G3, SOFAR 1600TL-G3, SOFAR 2200TL-G3)

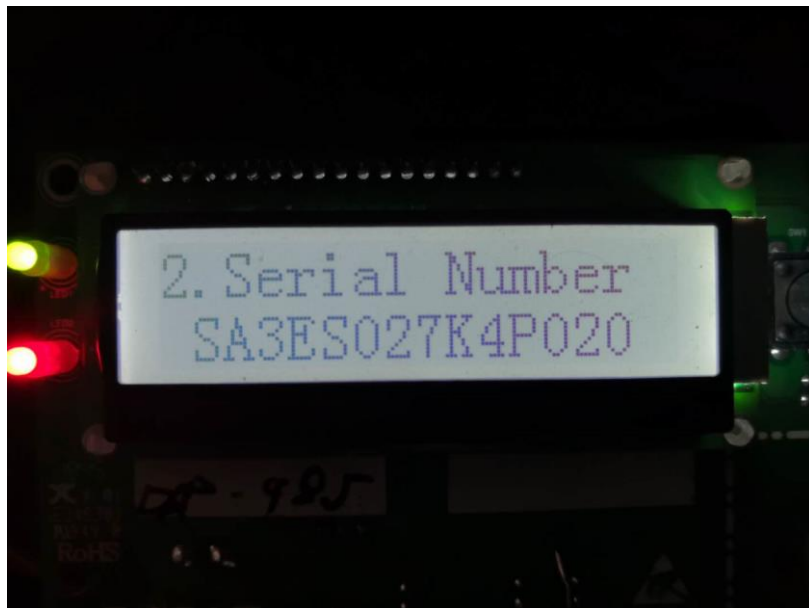

Software Number SOFAR 3000TL-G3

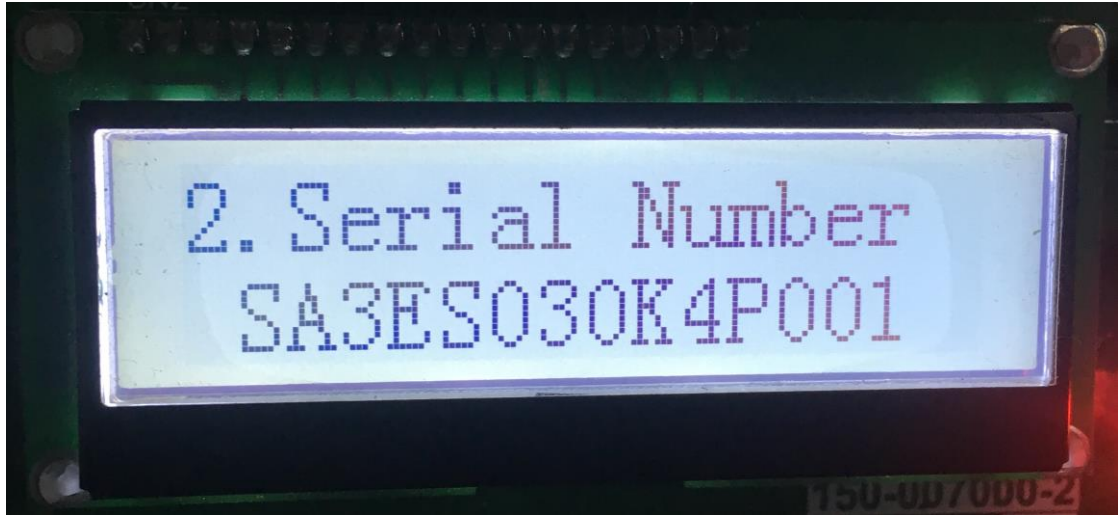

Software version



2 ELECTRICAL SCHEMES

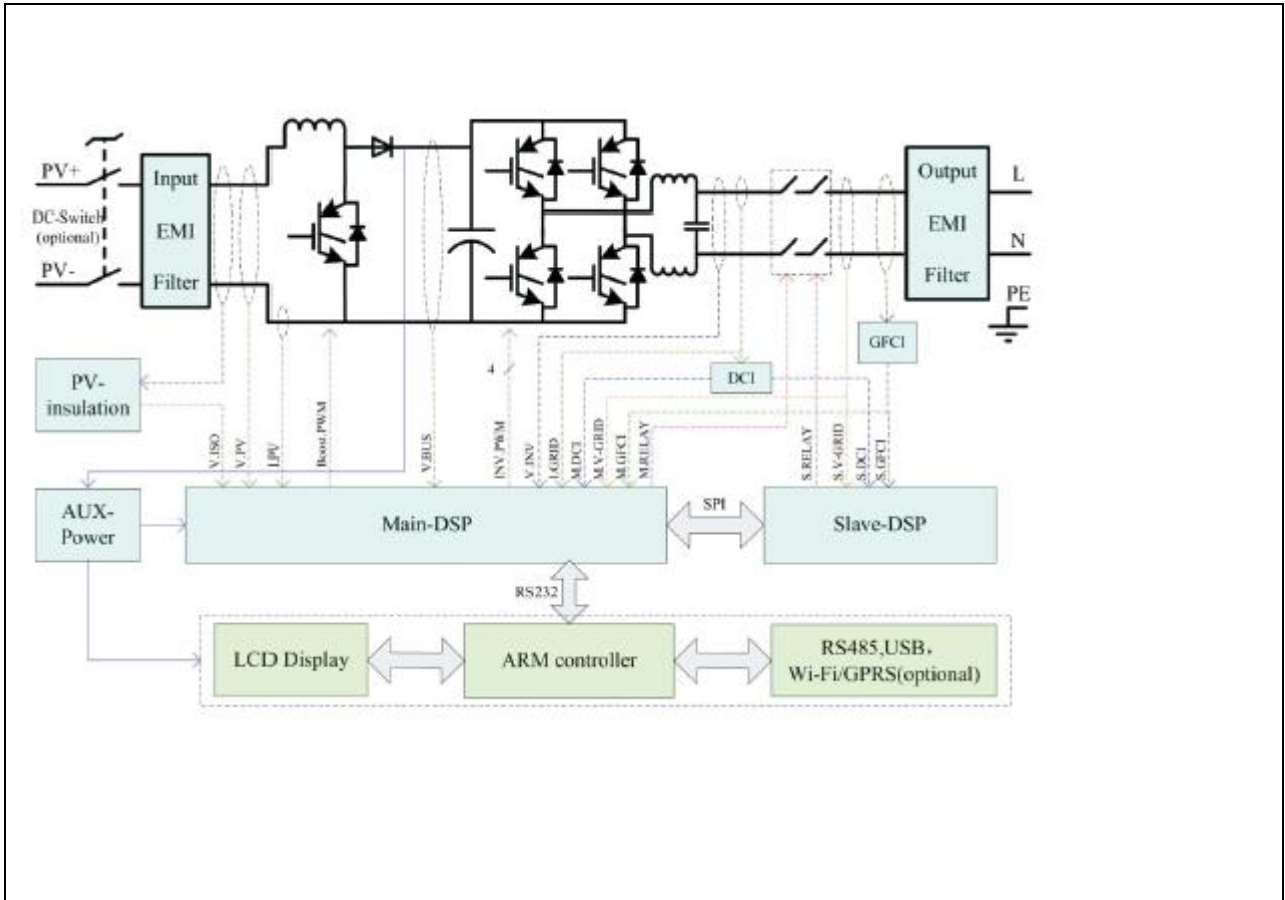

ATTACHMENT II

(Testing information)

1 TESTING CIRCUIT

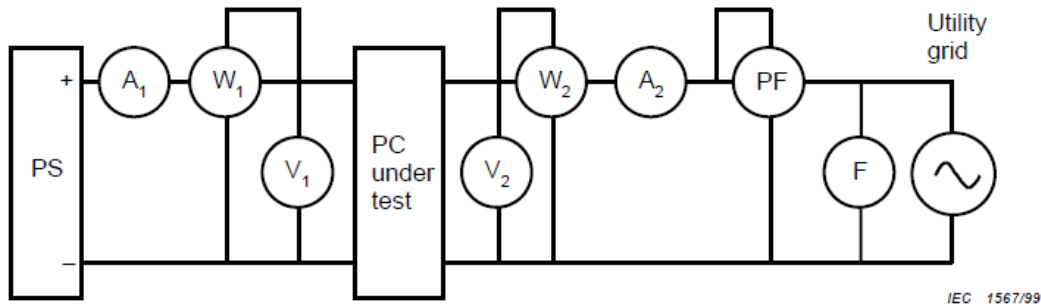

Figure 1b – Utility-interactive type

IEC 1567/99

- | | |
|---|-------------------------------------|
| PC power conditioner | L load |
| PS variable voltage-current d.c. power supply | F frequency meter |
| A ₁ DC ammeter | V ₁ DC voltmeter |
| A ₂ AC or d.c. ammeter | V ₂ AC or d.c. voltmeter |
| W ₁ DC wattmeter | PF power factor meter |
| W ₂ AC or d.c. wattmeter | |

Current and voltage clamps have been connected to the inverter input/output for all the tests.
 All the tests and checks have been performed in accordance with the reference standard under testing.

2 TESTING EQUIPMENT

From	No.	Equipment Name	Model No.	Equipment No.	Calibration Date	Equipment calibration due date
Sofarsolar	1	Digital oscilloscope	DS05014A	MY5007026 6	2019-02-13	2020-02-12
	2	Voltage probe	SI-9110	111541	2019-02-13	2020-02-12
	3	Voltage probe	SI-9110	152627	2019-02-13	2020-02-12
	4	Voltage probe	SI-9110	111134	2019-02-13	2020-02-12
	5	Power analyzer	WT3000	91N610888	2019-02-13	2020-02-12
	6	Current probe	i1000s	29503223	2019-02-13	2020-02-12
	7	Current probe	i1000s	30413448	2019-02-13	2020-02-12
	8	Current probe	CP5150	C150150008	2019-02-13	2020-02-12
	9	Temperature & Humidity meter	TH101B	2010302452 20	2019-02-13	2020-02-12
	10	Temperature & Humidity Chamber	HGTP-225R	HG1303080 1	2019-02-13	2020-02-12
SGS	11	True RMS Multimeter	Fluke / 289C	GZE012-53	2019-02-26	2020-02-25

Items	Specifications
1) PV array simulator	
a) Voltage range	0 – 1000Vdc (0.01V step)
b) Current range	0 – 40A (0.01A step)
2) AC power source	
a) Output wiring	Three phase
b) Output capacity	30KVA
c) Output voltage	10-300Vrms
d) Output frequency	45-65Hz
e) Voltage stability	± 100ppm/°C
f) Output voltage distortion	0.05% max.
3) Digital meter	
a) Voltage range	0 – 1000Vdc, 0 – 600Vrms
b) Current range	0 – 30A
c) Frequency range (accuracy)	0.2%
d) Measurement items	Voltage (V) Current (A) Active power (W) Reactive power (Var) Volt-ampere (VA) Power factor (PF) Frequency (Hz) Electric energy (Wh)
4) Waveform recorder	
a) Sampling speed	1M/s
b) Recording device	Memory record and USB reading
c) Time accuracy	± 500ppm
5) AC load	
a) Resistive load	Maximum voltage: 300Vrms Current range: 0 – 100A Capacity: 30KW
b) Inductive load	Maximum voltage: 300Vrms Current range: 0 – 100A Capacity: 30KVA
c) Capacitive load	Maximum voltage: 300Vrms Current range: 0 – 100A Capacity: 30KVA

3 MEASUREMENT UNCERTAINTY

Magnitude	Uncertainty
Voltage measurement	±1.5 %
Current measurement	±2.0 %
Frequency measurement	±0.2 %
Time measurement	±0.2 %
Power measurement	±2.5 %
Phase Angle	±1°
Temperature	±3° C
<p>Note1: Measurements uncertainties showed in this table are maximum allowable uncertainties. The measurement uncertainties associated with other parameters measured during the tests are in the laboratory at disposal of the petitioner.</p> <p>Note2: Where the standard requires lower uncertainties that those in this table. Most restrictive uncertainty has been considered.</p>	